**Key Parameters**

$V_{DRM} / V_{RRM}$	2000 - 2500 V
$I_{FAVM}$	98 A ( $T_C=100\text{ }^\circ\text{C}$ )
$I_{FSM}$	2400 A
$V_{T0}$	0,82 V
$r_T$	2,0 m $\Omega$
$R_{thJC}$	0,185 K/W
Base plate	20 mm
Weight	160 g



For type designation please refer to actual short form catalog

<http://www.ifbip.com/catalog>

**Merkmale**

- Druckkontakt-Technologie für hohe Zuverlässigkeit
- Industrie-Standard-Gehäuse
- Elektrisch isolierte Bodenplatte

**Features**

- Pressure contact technology for high reliability
- Industrial standard package
- Electrically insulated base plate

**Typische Anwendungen**

- Gleichrichter für Antriebsapplikationen
- Gleichrichter für UPS
- Batterieladegleichrichter

**Typical Applications**

- Rectifier for drives applications
- Rectifiers for UPS
- Battery chargers

	DMX code digit	DMX code digit quantity
content of customer DMX code		
type designation	1..18	18
serial number	19..23	5
internal production order number	24..31	8
material number	32..41	10
date code (YY/WW)	42..45	4
add on for date code	46	1

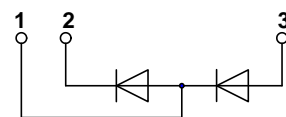

[www.ifbip.com](http://www.ifbip.com)  
[support@infineon-bip.com](mailto:support@infineon-bip.com)

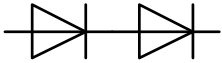

# Datenblatt / Data sheet



**Netz-Dioden-Modul**  
**Rectifier Diode Module**

## DD98N

Infineon Technologies Bipolar  
GmbH & Co. KG

DD98N

DD98N..K..-K

### Elektrische Eigenschaften / Electrical properties

Höchstzulässige Werte / Maximum rated values

Periodische Spitzensperrspannung repetitive peak reverse voltages	$T_{vj} = -40^{\circ}\text{C} \dots T_{vj\text{ max}}$	$V_{RRM}$	2000 2400	2200 2500	V V
Stoßspitzensperrspannung non-repetitive peak reverse voltage	$T_{vj} = +25^{\circ}\text{C} \dots T_{vj\text{ max}}$	$V_{RSM}$	2100 2500	2300 2600	V V
Durchlaßstrom-Grenzeffektivwert maximum RMS on-state current		$I_{FRMSM}$		160	A
Dauergrenzstrom average on-state current	$T_C = 100^{\circ}\text{C}$	$I_{FAVM}$		98	A
Stoßstrom-Grenzwert surge current	$T_{vj} = 25^{\circ}\text{C}, t_p = 10\text{ ms}$ $T_{vj} = T_{vj\text{ max}}, t_p = 10\text{ ms}$	$I_{FSM}$		2.400 2.000	A A
Grenzlastintegral $I^2t$ -value	$T_{vj} = 25^{\circ}\text{C}, t_p = 10\text{ ms}$ $T_{vj} = T_{vj\text{ max}}, t_p = 10\text{ ms}$	$I^2t$		28.800 20.000	A <sup>2</sup> s A <sup>2</sup> s

### Charakteristische Werte / Characteristic values

Durchlaßspannung on-state voltage	$T_{vj} = T_{vj\text{ max}}, I_F = 300\text{ A}$	$V_F$	max.	1,53	V
Schleusenspannung threshold voltage	$T_{vj} = T_{vj\text{ max}}$	$V_{(TO)}$		0,82	V
Ersatzwiderstand slope resistance	$T_{vj} = T_{vj\text{ max}}$	$r_T$		2	mΩ
Sperrstrom reverse current	$T_{vj} = T_{vj\text{ max}}, V_R = V_{RRM}$	$I_R$	max.	25	mA
Isolations-Prüfspannung insulation test voltage	RMS, $f = 50\text{ Hz}, t = 1\text{ sec}$ RMS, $f = 50\text{ Hz}, t = 1\text{ min}$	$V_{ISOL}$		3,0 2,5	kV kV

### Thermische Eigenschaften / Thermal properties

Innerer Wärmewiderstand thermal resistance, junction to case	pro Modul / per Module, $\Theta = 180^{\circ}\text{ sin}$ pro Zweig / per arm, $\Theta = 180^{\circ}\text{ sin}$ pro Modul / per Module, DC pro Zweig / per arm, DC	$R_{thJC}$	max.	0,195 0,390 0,185 0,370	°C/W °C/W °C/W °C/W
Übergangs-Wärmewiderstand thermal resistance, case to heatsink	pro Modul / per Module pro Zweig / per arm	$R_{thCH}$	max.	0,05 0,10	°C/W °C/W
Höchstzulässige Sperrschichttemperatur maximum junction temperature		$T_{vj\text{ max}}$		150	°C
Betriebstemperatur operating temperature		$T_{c\text{ op}}$		- 40...+150	°C
Lagertemperatur storage temperature		$T_{stg}$		- 40...+150	°C

prepared by:	A.G.	date of publication:	23.05.2016
approved by:	M. S.	revision:	3.2

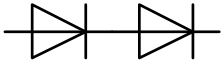

# Datenblatt / Data sheet



**Netz-Dioden-Modul**  
**Rectifier Diode Module**

## DD98N

Infineon Technologies Bipolar  
GmbH & Co. KG

### Mechanische Eigenschaften / Mechanical properties

Gehäuse, siehe Anlage case, see annex			Seite 4 page 4	
Si-Element mit Druckkontakt Si-pellet with pressure contact				
Innere Isolation internal insulation			AIN	
Anzugsdrehmoment für mechanische Anschlüsse mounting torque	Toleranz $\pm 15\%$	M1	4	Nm
Anzugsdrehmoment für elektrische Anschlüsse terminal connection torque	Toleranz $\pm 10\%$	M2	4	Nm
Gewicht weight		G	typ. 160	g
Kriechstrecke creepage distance			15	mm
Schwingfestigkeit vibration resistance	f = 50 Hz		50	m/s <sup>2</sup>
	file-No.		E 83335	

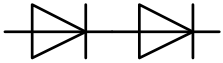

# Datenblatt / Data sheet



Netz-Dioden-Modul  
Rectifier Diode Module

## DD98N

Infineon Technologies Bipolar  
GmbH & Co. KG

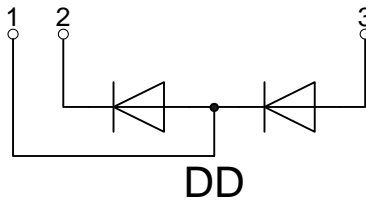
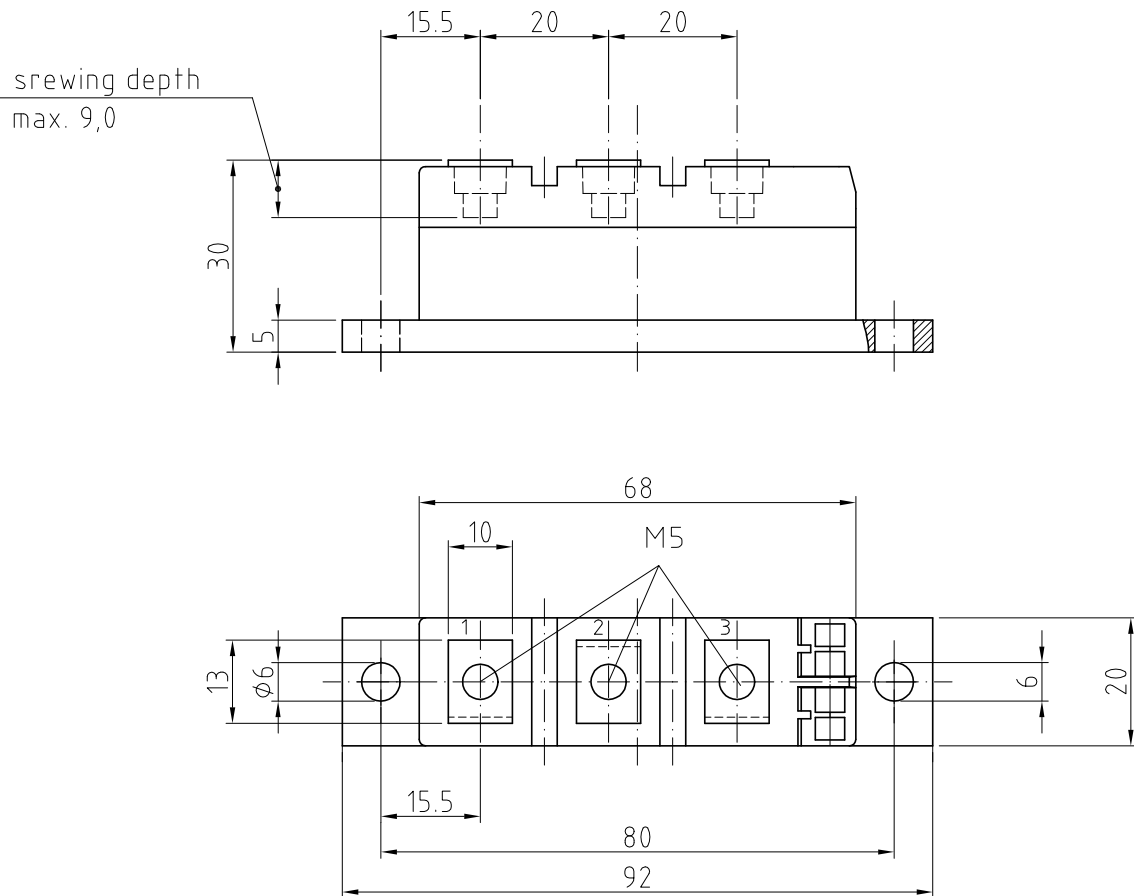

DD

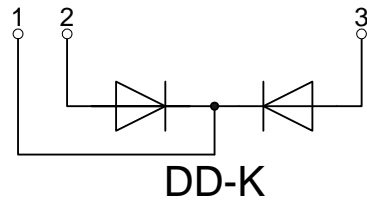

DD-K

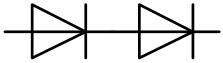

Analytische Elemente des transienten Wärmewiderstandes  $Z_{thJC}$  für DC  
Analytical elements of transient thermal impedance  $Z_{thJC}$  for DC

Pos. n	1	2	3	4	5	6	7
$R_{thn}$ [°C/W]	0,0233	0,0433	0,134	0,17			
$T_n$ [s]	0,00137	0,0175	0,325	2,11			

Analytische Funktion / Analytical function:

$$Z_{thJC} = \sum_{n=1}^{n_{max}} R_{thn} \left( 1 - e^{-\frac{t}{T_n}} \right)$$

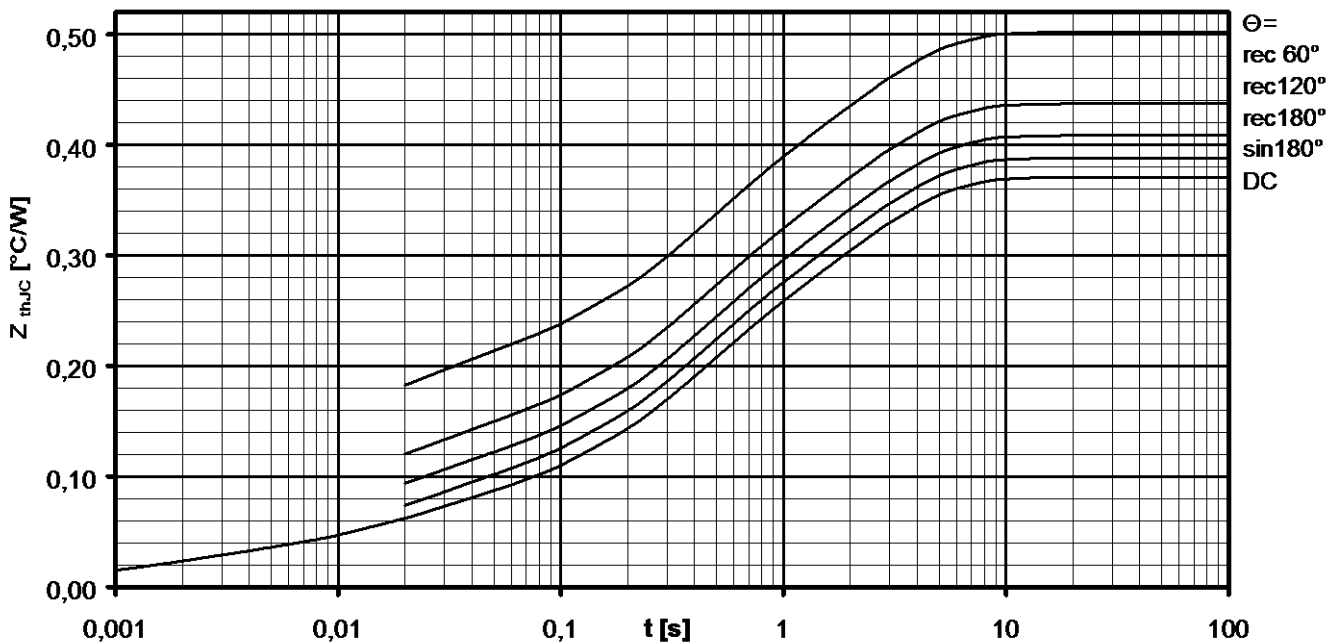

Transienter innerer Wärmewiderstand je Zweig / Transient thermal impedance per arm  $Z_{thJC} = f(t)$

Parameter: Stromflußwinkel  $\Theta$  / Current conduction angle  $\Theta$

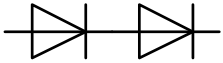

Natürliche Kühlung / Natural cooling  
3 Module pro Kühler / 3 modules per heatsink  
Kühler / Heatsink type: KM14 (50W)

**Analytische Elemente des transienten Wärmewiderstandes  $Z_{thCA}$**   
**Analytical elements of transient thermal impedance  $Z_{thCA}$**

Pos. n	1	2	3	4	5	6	7
$R_{thn}$ [°C/W]	0,007	0,141	0,119	2,133			
$T_n$ [s]	0,701	4,72	42,5	910			

Verstärkte Kühlung / Forced cooling  
3 Module pro Kühler / 3 modules per heatsink  
Kühler / Heatsink type: KM14 (Papst 4650)

**Analytische Elemente des transienten Wärmewiderstandes  $Z_{thCA}$**   
**Analytical elements of transient thermal impedance  $Z_{thCA}$**

Pos. n	1	2	3	4	5	6	7
$R_{thn}$ [°C/W]	0,007	0,141	0,119	0,583			
$T_n$ [s]	0,701	4,72	42,5	249			

Analytische Funktion / Analytical function:

$$Z_{thCA} = \sum_{n=1}^{n_{max}} R_{thn} \left( 1 - e^{-\frac{t}{T_n}} \right)$$

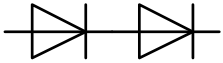

Netz-Dioden-Modul  
Rectifier Diode Module

## DD98N

Infineon Technologies Bipolar  
GmbH & Co. KG

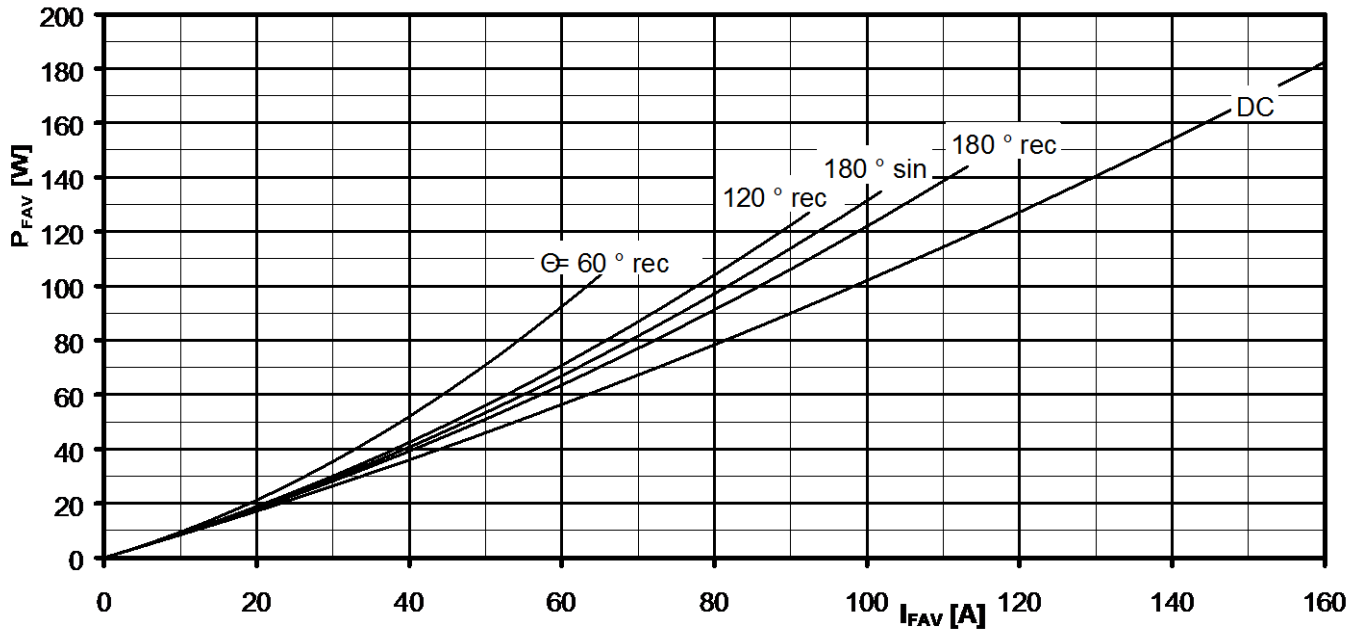

Durchlassverlustleistung je Zweig / On-state power loss per arm  $P_{FAV} = f(I_{FAV})$

Parameter: Stromflußwinkel / Current conduction angle  $\Theta$

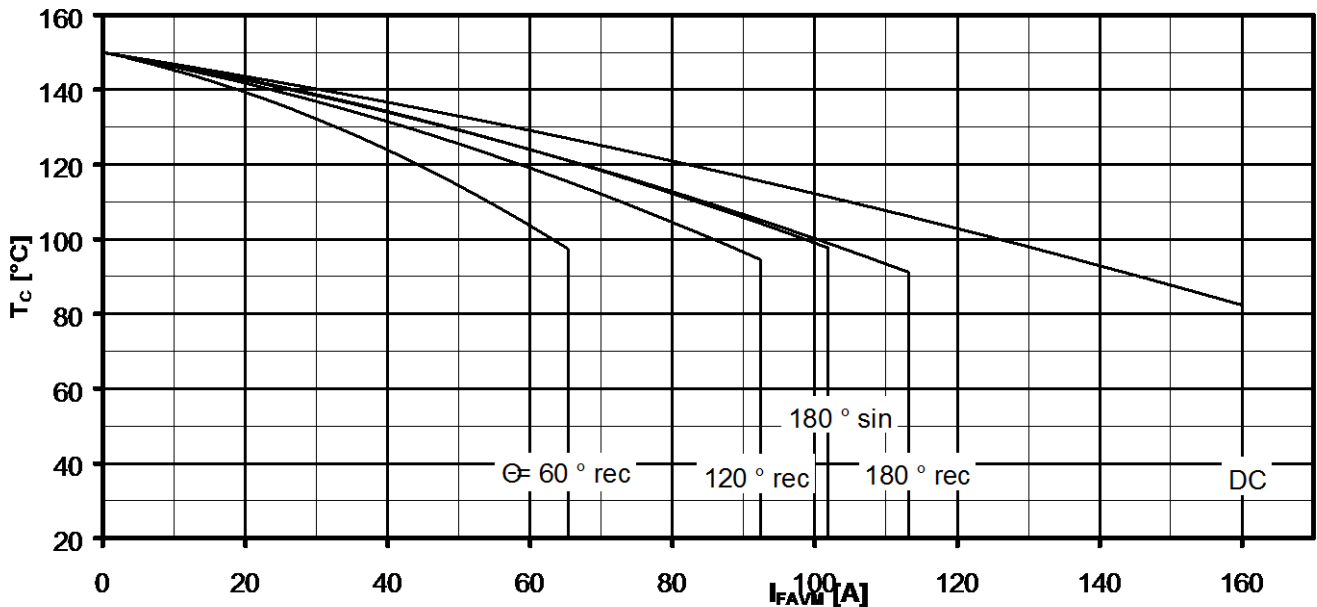

Höchstzulässige Gehäusetemperatur / Maximum allowable case temperature  $T_C = f(I_{FAVM})$

Strombelastung je Zweig / Current load per arm

**Berechnungsgrundlage  $P_{TAV}$**  (Schaltverluste gesondert berücksichtigen)  
**Calculation base  $P_{TAV}$**  (switching losses should be considered separately)

Parameter: Stromflußwinkel  $\Theta$  / Current conduction angle  $\Theta$

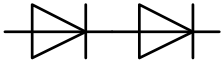

**Netz-Dioden-Modul**  
**Rectifier Diode Module**

## DD98N

Infineon Technologies Bipolar  
GmbH & Co. KG

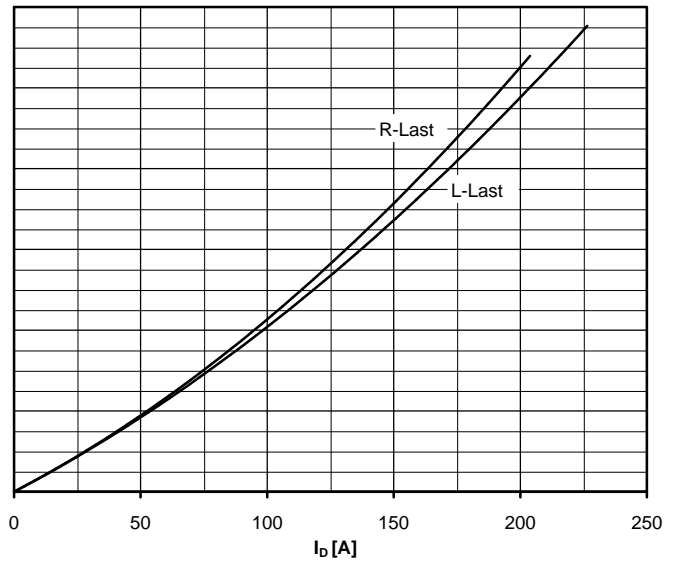
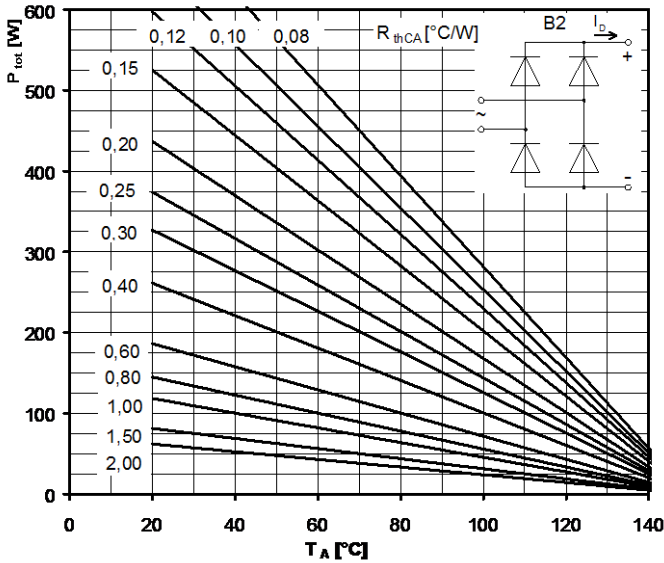

**Höchstzulässiger Ausgangsstrom / Maximum rated output current  $I_D$**

B2- Zweipuls-Brückenschaltung / Two-pulse bridge circuit

Gesamtverlustleistung der Schaltung / Total power dissipation at circuit  $P_{tot}$

Parameter:

Wärmewiderstand zwischen den Gehäusen und Umgebung / Thermal resistance cases to ambient  $R_{thCA}$

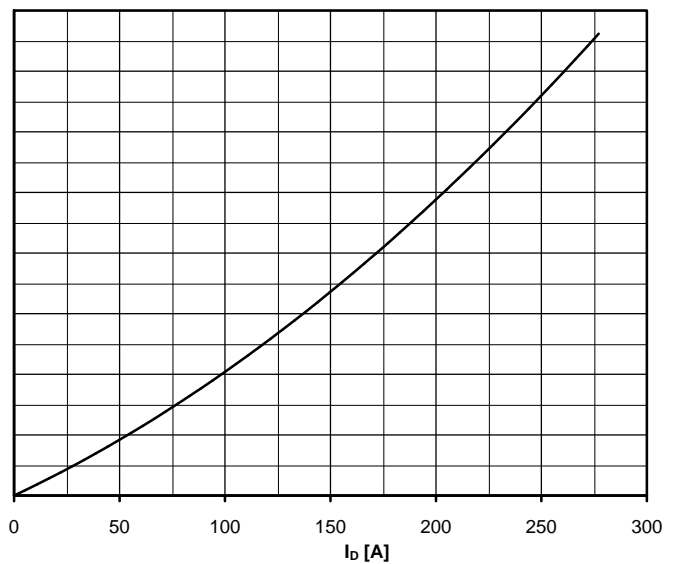
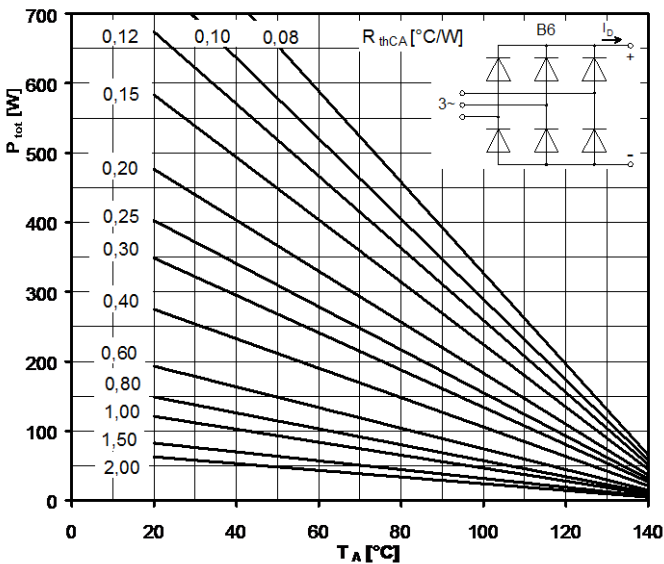

**Höchstzulässiger Ausgangsstrom / Maximum rated output current  $I_D$**

B6- Sechspuls-Brückenschaltung / Six-pulse bridge circuit

Gesamtverlustleistung der Schaltung / Total power dissipation at circuit  $P_{tot}$

Parameter:

Wärmewiderstand zwischen den Gehäusen und Umgebung / Thermal resistance cases to ambient  $R_{thCA}$



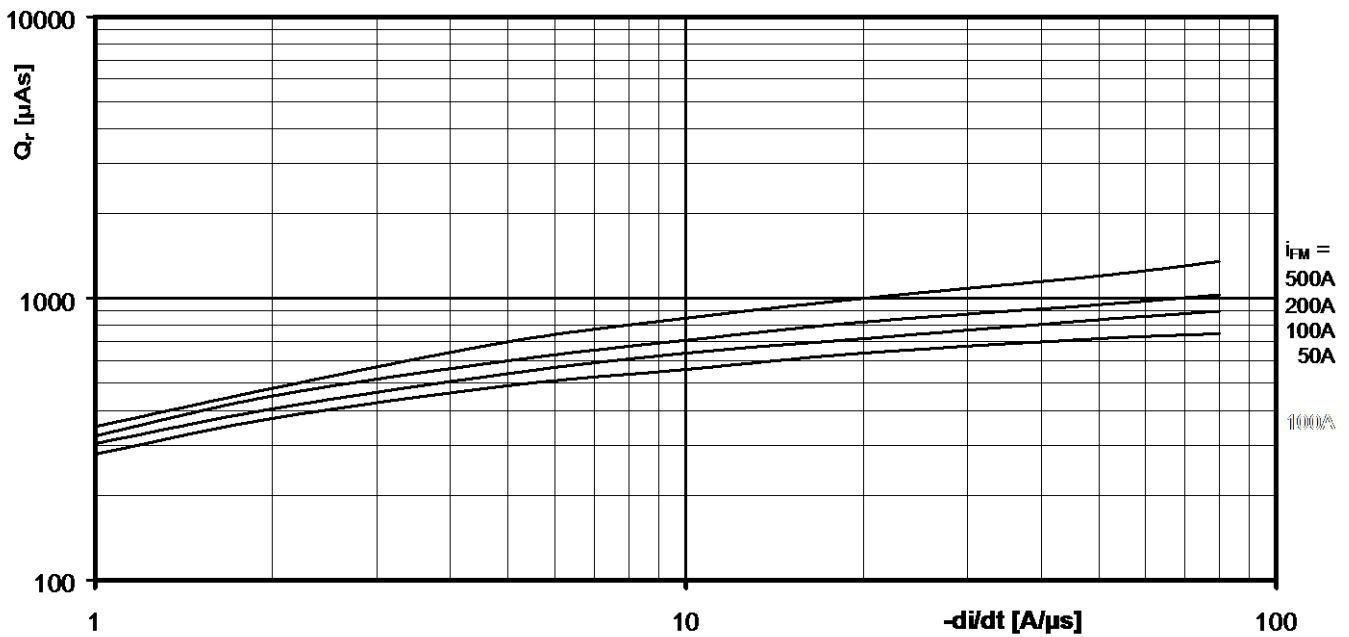
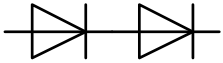

Sperrverzögerungsladung / Recovered charge  $Q_r = f(-di/dt)$

$$T_{vj} = T_{vjmax}, V_R \leq 0,5 V_{RRM}, V_{RM} = 0,8 V_{RRM}$$

Parameter: Durchlaßstrom / On-state current  $i_{FM}$

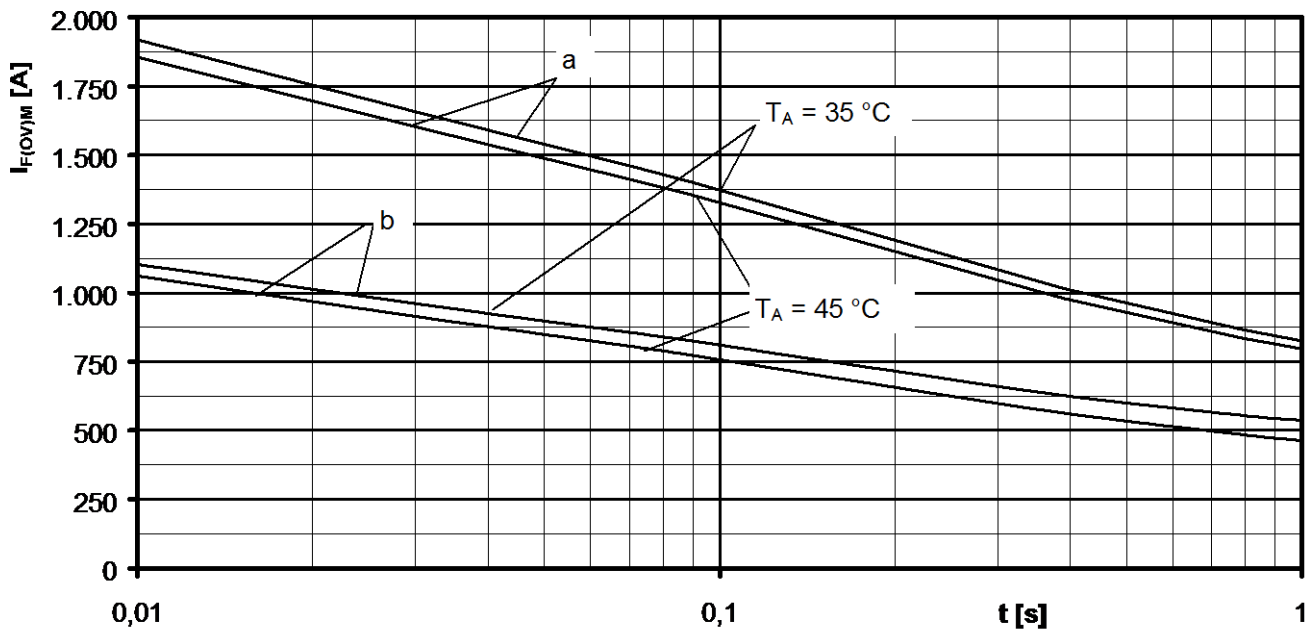

Grenzstrom je Zweig / Maximum overload on-state current per arm  $I_{F(OV)M} = f(t), V_{RM} = 0,8 V_{RRM}$

a: Leerlauf / No-load conditions

b: Vorlaststrom je Zweig / Pre-load current per arm  $I_{FAV(vor)} = I_{FAVM}$

$T_a = 35^\circ\text{C}$ , verstärkte Luftkühlung / Forced air cooling    Kühlkörper / Heatsink type: KM14 (Papst 4650)

$T_a = 45^\circ\text{C}$ , natürliche Luftkühlung / Natural air cooling    Kühlkörper / Heatsink type: KM14 (50W)

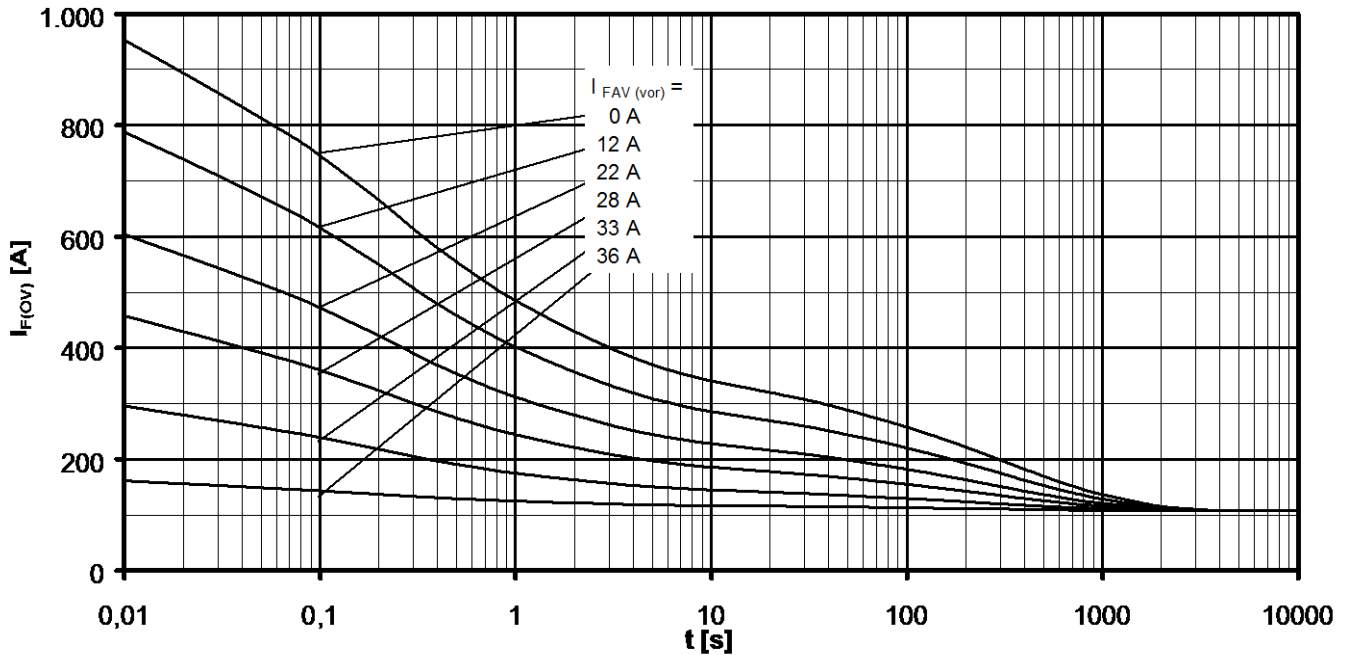
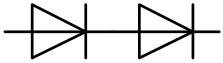

Überstrom je Zweig / Overload on-state current  $I_{F(ov)}$

B6- Sechspuls-Brückenschaltung, 120° Rechteck / Six-pulse bridge circuit, 120° rectangular

Kühlkörper / Heatsink type KM14 (50W) Natürliche Kühlung bei / Natural cooling at  $T_A = 45^\circ\text{C}$

Parameter: Vorlaststrom je Zweig / Pre-load current per arm  $I_{FAV(vor)}$

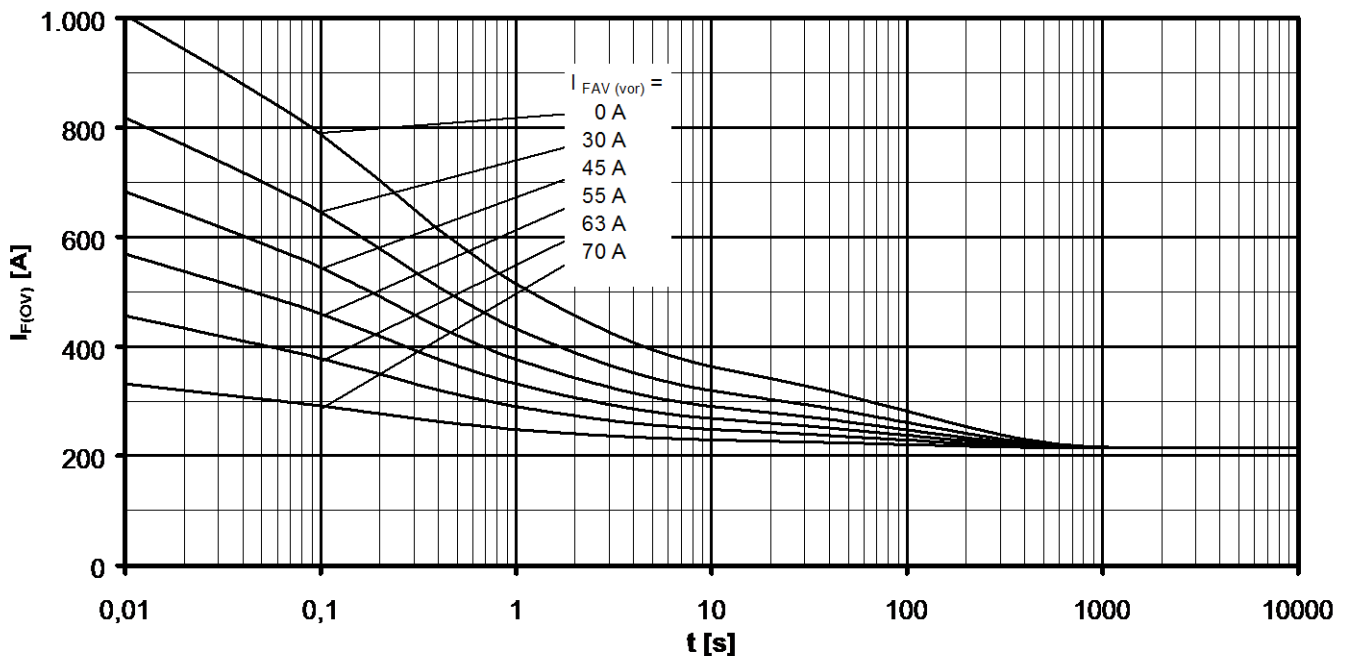

Überstrom je Zweig / Overload on-state current  $I_{F(ov)}$

B6- Sechspuls-Brückenschaltung, 120° Rechteck / Six-pulse bridge circuit 120° rectangular

Kühlkörper / Heatsink type KM14 (Papst 4650) Verstärkte Kühlung bei / Forced cooling at  $T_A = 35^\circ\text{C}$

Parameter: Vorlaststrom je Zweig / Pre-load current per arm  $I_{FAV(vor)}$

**This datasheet has been downloaded from:**

**[datasheet.eeworld.com.cn](http://datasheet.eeworld.com.cn)**

**Free Download**

**Daily Updated Database**

**100% Free Datasheet Search Site**

**100% Free IC Replacement Search Site**

**Convenient Electronic Dictionary**

**Fast Search System**

**[www.EEworld.com.cn](http://www.EEworld.com.cn)**